

# A Communication-Assisted Overcurrent Protection Scheme for Radial Distribution Systems With Distributed Generation

Vassilis C. Nikolaidis, *Member, IEEE*, Evangelos Papanikolaou, and Anastasia S. Safigianni, *Senior Member, IEEE*

**Abstract**—Conventional overcurrent protection schemes for radial distribution systems usually attempt to coordinate a recloser at the beginning of the feeder with the fuses on the laterals. The integration of distributed generation in distribution systems leads to problems related to protection coordination that are difficult to be solved by applying conventional protection techniques. This paper proposes an efficient communication-based protection scheme that implements common directional overcurrent relays instead of reclosers at the line, assisted by intertripping and blocking transfer functions. The proposed protection strategy guarantees selectivity regardless of whether the generating units are connected to the network or not, and can be designed retaining either the fuse-blowing or fuse-saving philosophy. Meaningful conclusions are derived from the application of the scheme on a test distribution system.

**Index Terms**—Directional elements, distributed generation (DG), distribution systems, overcurrent protection, protection coordination, signal transfer

## I. INTRODUCTION

A CONVENTIONAL overcurrent protection scheme designed for radial distribution lines is usually based on the use of a recloser, at the beginning of the feeder, which is coordinated with the downstream protection means (overcurrent relays and/or sectionalizers) on the main line and with the fuses on the laterals [1]. It is also common to apply a reclosing circuit breaker (CB) at the beginning of the feeder with one or two reclosers at the midpoint and the end of the feeder.

It is a challenging task to coordinate the recloser(s) in a radial distribution line with fuses on the laterals when distributed generation (DG) units are present at the line. Microprocessor-based reclosers with adaptive capabilities have been proposed in [2] for achieving protection coordination in such a distribution network. This scheme applies effectively, but it suggests that the DG unit will be disconnected before the first reclosing operation. On the other hand, nonadaptive microprocessor-based reclosers in conjunction with directional

elements have been proposed in [3], but this method cannot check the coordination between protective relays after connecting each DG in the network. Coordination between reclosers and fuses has been obtained in [4] with the use of synchronized measurements and off-line design calculations. Funmilayo and Butler-Purry [5] proposed to replace the fuses on the laterals where DG is connected with numerical reclosers and relays in order to maintain coordination between the overcurrent protection devices. This methodology has been tested in two template distribution systems and it seems to work adequately, despite the fact that some fuse fatigue issues could not be avoided.

Directional overcurrent relays are mainly used in ring-type distribution systems. However, directional overcurrent protection was introduced to radial distribution systems [6], [7] due to the massive DG integration experienced the last years. Directional overcurrent relays with communication capabilities are used in a radial network in [8] to minimize the number of disconnected DG units in case of faults. Reclosing operations are also performed to restore the system.

Inherent fault direction discrimination and fault location is obtained if distance relays are applied in distribution networks [9], [10]. Dedicated fault location algorithms based on neural networks [11], [12] have been recently proposed for the design of protection schemes in distribution systems with DG. However, the speed and the complexity of those methods make them unfavorable in terms of protection needs.

There are also current-based algorithms proposed for the design of protection schemes in radial distribution systems with DG. The calculation of the steady state fault current magnitudes from steady state network equivalent reduction is proposed in [13], while the current phase angle comparison is used in [14] as a criterion for a pilot relaying scheme.

The differential protection principle has been successfully tested as a unit protection scheme in microgrids [15]–[17]. In [18], the same principle has been tested in modern urban distribution systems taking advantage from the IEC-61850 Standard, while Karady *et al.* [19] deployed a pilot-based differential protection scheme on the IEEE 34-bus test distribution system.

This paper proposes an efficient communication-based overcurrent protection scheme for distribution lines with DG. Section II presents a detailed description of this scheme. A comparison with different protection schemes is included in the same section, while the limitations of the method and

Manuscript received July 31, 2014; revised November 13, 2014 and January 17, 2015; accepted March 2, 2015. Date of publication March 20, 2015; date of current version December 19, 2015. Paper no. TSG-00773-2014.

The authors are with the Department of Electrical and Computer Engineering, Democritus University of Thrace, Xanthi 67100, Greece (e-mail: vnikolai@ee.duth.gr).

Color versions of one or more of the figures in this paper are available online at <http://ieeexplore.ieee.org>.

Digital Object Identifier 10.1109/TSG.2015.2411216

1949-3053 © 2015 IEEE. Personal use is permitted, but republication/redistribution requires IEEE permission.

See [http://www.ieee.org/publications\\_standards/publications/rights/index.html](http://www.ieee.org/publications_standards/publications/rights/index.html) for more information.

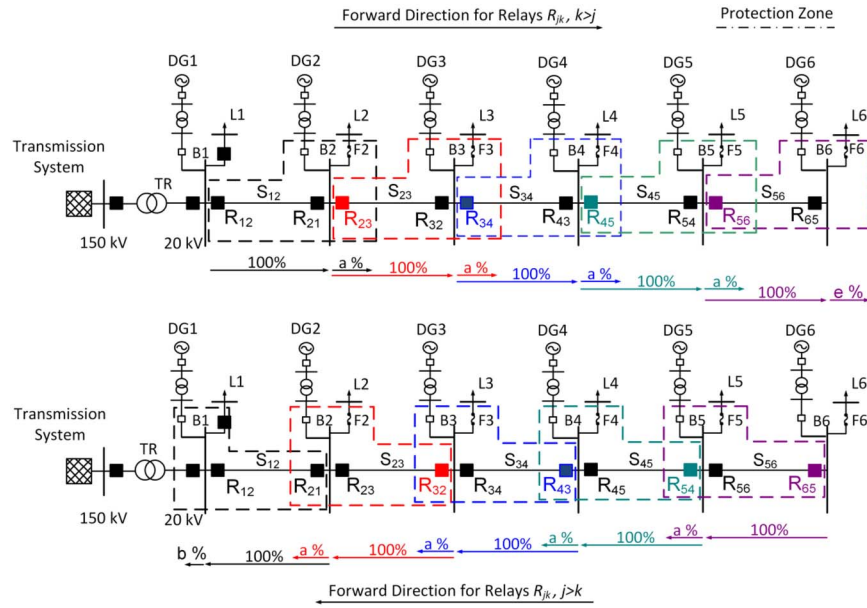

Fig. 1. Primary protection zones.

the economic feasibility of the required investment are also discussed. Section III presents the results derived from the application of the protection scheme on a test distribution system, while Section IV summarizes the derived conclusion.

## II. PROPOSED OVERCURRENT PROTECTION SCHEME

This paper proposes a simple overcurrent protection scheme that is based on the use of numerical directional overcurrent relays for the protection of a radial distribution line with DG units instead of relying primarily to a recloser at the beginning of the line. Any modern intelligent electronic device having common communication capabilities can be used for the implementation of this scheme. The proposed protection scheme can be designed retaining either the fuse-blowing (FB) or fuse-saving (FS) philosophy as if a common reclosing scheme was in operation.

The following assumptions have been made in the analysis.

- 1) Only synchronous DG units have been considered.
- 2) The DG units are connected to the main trunk.
- 3) The DG units operate in a constant power factor mode.

### A. Design Philosophy

The design logic of the protection scheme proposes directional overcurrent relays to be applied at both ends of every line section, as shown in Fig. 1. Every relay in Fig. 1 is represented by the symbol  $R$  having subscripts which indicate the forward fault direction for the particular relay. In other words, for the directional overcurrent relay  $R_{jk}$  a forward fault corresponds to a short-circuit current that flows from buses  $j$  to  $k$ . It is evident that current and voltage measurements are needed from any line segment terminals as inputs to the directional element of the relays. Therefore, individual current and voltage transformers are needed to be installed at those places.

In order to set the directional element accurately, a design study should be performed to define the expected range of angles formed between the measured short-circuit currents and

the polarizing voltage [20] for all the possible faults magnitudes and locations along the feeder. The proposed protection scheme indicates that every relay  $R_{jk}$  should be set to clear faults occurring in the forward direction within their primary protection zone. In other words, every overcurrent directional relay is set to react only for faults flowing into their primary protected zone.

Overlapping is applied when defining the primary protection zones of the relays. In particular, the primary protection zone of the relay  $R_{jk}$  is formed in such a way that it covers the line segment  $S_{jk}$  plus an additional length of the nearby line section  $S_{j+1,k+1}$  in the relay's forward direction. For example, the relay  $R_{23}$  is set to cover the whole line segment  $S_{23}$  plus  $a\%$  of the length of the subsequent section  $S_{34}$ . On the other hand, the opposite relay  $R_{32}$  is set to cover the whole line segment  $S_{23}$  plus  $a\%$  of the length of the subsequent section  $S_{12}$  in its forward direction. Of course, the primary protection zone of the relay overlaps that of the fuse in the adjacent lateral. The overlapping protection zones in both directions are shown with dashed lines in Fig. 1.

Note that at the marginal positions (e.g., at buses B1 and B6) the overlapping principle cannot be applied as straightforward as it is applied for the line segments. Regarding the relay  $R_{21}$  the maximum overreaching percentage  $b\%$  is determined from the need to form a protection zone that overlaps the primary differential protection zone of the transformer and that of the bus B1. Similarly, the maximum overreaching percentage  $e\%$  of the relay  $R_{56}$  is determined from the need to form a protection zone that simply overlaps the primary protection zone of the fuse F6.

Each relay has to be set with two definite-time (DT) stages for its phase and two DT stages for its earth overcurrent element. The first-stage DT setting is used for sensing forward phase/earth faults occurring everywhere within the primary protection zone of the relay. A time-delayed, second-stage DT setting is applied as a backup function in case the primary protection function of the downstream relay fails to operate.

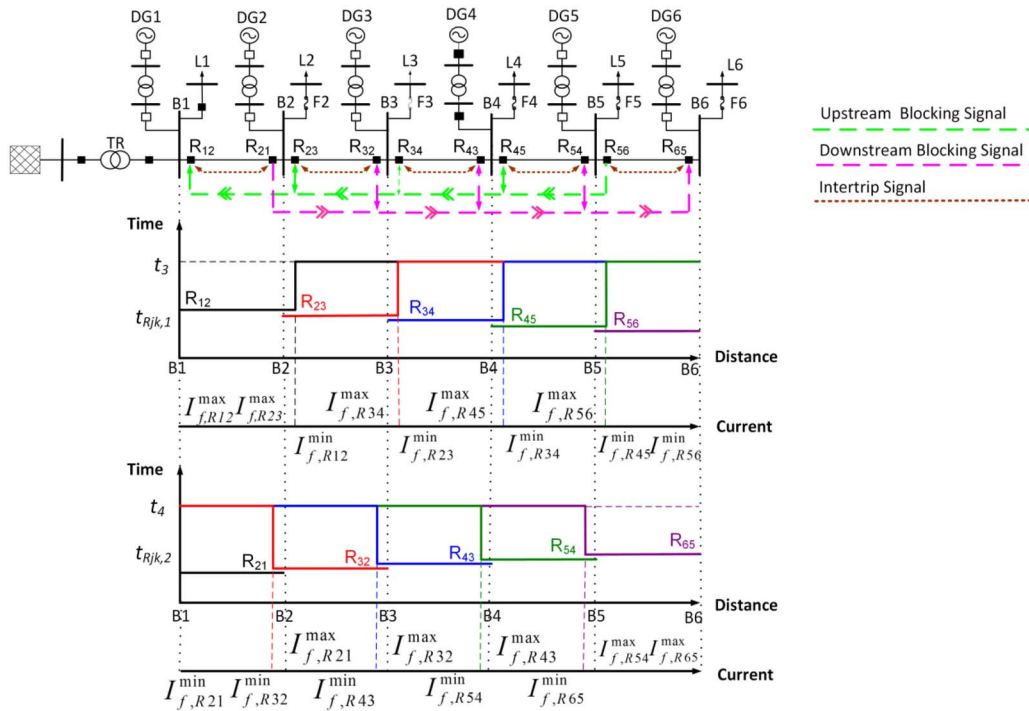

Fig. 2. Two-step zone overlapping scheme and communication path.

Thus, if a relay fails to operate for a phase/earth fault within its primary zone, the upstream relay looking into the same direction is expected to operate after a sufficient coordination time interval (CTI).

This two-step zone overlapping scheme is shown in Fig. 2. Every differently colored line in the diagrams indicates the two DT stages of the phase/earth overcurrent element of the relays. The fastest DT setting corresponds to a tripping time equal to  $t_{Rjk,1}$  or  $t_{Rjk,2}$ , expected for any fault occurring within the primary protection zone of the relay  $R_{jk}$  (obviously  $t_{Rjk,1}$  and  $t_{Rjk,2}$  refer to the first-stage tripping time of relays looking to opposite directions and in general they could be set equal). The slower DT setting corresponds to a constant tripping time ( $t_3$  for forward and  $t_4$  for reverse relays, respectively), that is coordinated with an adequate  $CTI_{Rjk}$  in relevance to the first-stage time delay, expected substantially for any fault occurring within the primary zone of the neighboring relay.

The relay  $R_{65}$  is set with a second, time-delayed DT element (shown with dashed line in Fig. 2) for its own primary protection zone because none neighboring relay can backup  $R_{65}$  for faults in its primary zone. The same is assumed for the relay  $R_{12}$ , although the overcurrent element of the transformer or bus differential relay could be used as a backup protection.

The overlapping logic described earlier is necessary in order to ensure that any relay  $R_{jk}$  will operate for a fault occurring everywhere inside the line segment  $S_{jk}$ , even at its limits. Since fault currents have similar magnitudes when appearing in the proximity of a protection zone limit, an underreaching scheme would negatively affect the dependability of the proposed method for those faults. On the other hand, the security of the proposed protection scheme is guaranteed by configuring a communication path between the relays.

Such a communication path, shown with dashed and dotted lines in the one-line diagram in Fig. 2, could be an Ethernet network that interconnects the relays through single-mode fiber optic cables and switches [21].

Suppose now that a fault occurs within the primary protection zone of the relay  $R_{34}$ . Without any DG present in the line, this fault will simultaneously be sensed from all the upstream relays looking to the forward direction; that are the relays  $R_{12}$ ,  $R_{23}$ , and  $R_{34}$ . Selectivity requires that only the shortest section of the power system should be disconnected due to a fault. Thus, only the relay  $R_{34}$  must trip its CB leaving the upstream distribution system in operation.

The backup protection zone, meaning the second stage of the relay  $R_{12}$ , marginally reaches the faulted section  $S_{34}$ , whereas  $R_{23}$  second stage reach does clearly cover the whole section  $S_{34}$ . Under specific circumstances, those relays could trip both, in order to clear the assumed fault. Hence, it is a matter to prevent the tripping of the relays  $R_{12}$  and  $R_{23}$  in order to preserve selectivity. If the fault is located in a distance that is larger than the  $a\%$  length of the line section  $S_{34}$ , as measured from bus B3, the relay  $R_{12}$  cannot trip. As for the relay  $R_{23}$ , the CTI between the relay's  $R_{34}$  first-stage time-delay and the relay's  $R_{23}$  second-stage time-delay, provides the relay  $R_{34}$  enough time to trip first. There is only a selectivity issue if the fault occurs within the overlapping part of the primary zones of the relays  $R_{23}$  and  $R_{34}$ . In that case both relays would trip and selectivity would be lost. The backup relay  $R_{12}$  would not trip since the relays  $R_{23}$  and  $R_{34}$  would clear the fault.

To prevent this problem, the next rule is applied to all the relays looking to the same direction.

- 1) Whenever the first-stage phase/earth overcurrent element of a relay picks up, a blocking signal is sent to the

first-stage phase/earth element of all the upstream relays. The second-stage overcurrent function of the upstream relay stays unaffected from this blocking signal.

- 2) At the time the relay trip its CB, an intertripping signal to the CB at the opposite side of the same line section will be sent without any intentional delay to completely disconnect the faulted line section.

The intertripping of the opposite CBs is decided in order to speed up the fault clearing. Otherwise, the tripping time determined from the DT characteristic of the opposite relays should pass for the line section to be totally disconnected. In the grid-connected operation mode, the opposite relays could actually be neglected because of the intertripping, but they are set as a local backup function in case the intertripping fails. However, the opposite (reverse) relays are absolutely necessary if the distribution line operates in the island-mode. Assume, for example, that the interconnection of the line with the transmission system is lost and that a DG unit is operating, connected at bus B6. In that case, only the reverse relays can clear faults occurring on the line.

The time needed for the blocking signal to transfer between the relays before any of them trips is of great importance for setting the relays appropriately. In fact, the total time delay for a signal to be transmitted over a 10 km long, 100 Mb/s fiber cable is of the order of 15–40 ms [22], including the wire line latency, the switches latency and the processing time of sub-cycle relays. Note that this delay refers to the worst network topology in terms of communications delays which is the cascaded or ring type one, where the signals should transfer over the 10 km line section length in a cascaded manner. For any other Ethernet network topology, the transfer delay is significantly lower. Thus, selectivity is not affected since the relays are set with a time delay that is larger than the transfer delay. To sum up, if the Ethernet network is specified adequately in terms of architecture, redundancy, availability, performance, and cost [21], reliable operation is expected meaning that all packets will be transferred between the relays (through the switches) without any problem. Therefore, false or undesired blocking/tripping signals are not expected, except for the case where a physical cut occurs.

Assume again that a fault occurs within the primary protection zone of the relay  $R_{34}$ . Immediately after the relay  $R_{34}$  senses the fault it will send a blocking signal to the relays'  $R_{23}$  and  $R_{12}$  first-stage element. At the same time, it will send a tripping signal to the opposite CB. Hence, the faulted line section  $S_{34}$  will be disconnected, while the fastest element of all the upstream relays is blocked.

To summarize, if a fault occurs everywhere within a primary protection zone, the assigned relay will pick-up and at the same time it will send a blocking signal to the first-stage overcurrent element of all the upstream relays looking to the same direction. When the time delay of the assigned relay expires, it will trip its CB and simultaneously a second tripping signal will be transferred to the CB at the opposite side of the line section. If the assigned relay fails to assert a tripping order, the backup relay operates after a sufficient CTI to clear the fault. Note that this protection scheme operates effectively for phase and earth faults in both directions (even

for islanding conditions), irrelative if DG is present or not on the line. The latter will be further addressed in the following sections.

### B. Setting the Relays

A detailed fault analysis is needed in order to set appropriately the phase and earth overcurrent elements of the relays at every line section. This procedure includes the calculation of the minimum and maximum short-circuit currents expected to be seen from every relay of interest for all possible phase and earth fault conditions. To be more specific, the simulation of all common short-circuit types (three-phase, double-phase, double-phase-ground, and single-phase), occurring within the primary and secondary protection zone of every relay (that is in their forward direction), has to be performed considering minimum and maximum short-circuit conditions of the sources (equivalent source and connected DG units), any possible combination of DG connection locations and fault resistance.

To explain this procedure a little more, let us consider the relay  $R_{34}$ . Initially, short-circuit currents have to be calculated and stored for faults occurring within its primary protection zone, thus meaning within a distance range from just close-in to the relay  $R_{34}$  up to  $a\%$  of the next line segment  $S_{45}$ . All possible fault and network conditions described earlier should be taken into account in this analysis.

The maximum ( $I_{pf,R_{34}}^{\max}$ ) and minimum ( $I_{pf,R_{34}}^{\min}$ ) of all the phase fault currents calculated following the described methodology define the range of short-circuit current magnitudes that can be sensed from the phase element of the relay  $R_{34}$  within its primary zone, under all possible network and fault conditions.  $I_{ef,R_{34}}^{\max}$  and  $I_{ef,R_{34}}^{\min}$  are, respectively, the maximum and minimum short-circuit currents for earth faults occurring within the primary protection zone of the relay  $R_{34}$ . As an example, the largest phase fault current within the primary zone of the relay  $R_{34}$  has been calculated for a three-phase fault close-in to the relay in case that two DG units are connected on bus B3, while the smallest one for a single-phase fault occurring at the  $a\%$  distance of the line segment  $S_{45}$  when two DG units are connected on the buses B1 and B4.

Obviously, if one knows the minimum short-circuit magnitudes expected to be seen from any relay within its primary zone, then he can directly determine the first-stage ( $I_{pu1}$ ) and second-stage ( $I_{pu2}$ ) overcurrent setting (in primary A) of the phase/earth overcurrent element, respectively, of the relay  $R_{jk}$ . This is graphically shown in Fig. 3, where the two DT curves are illustrated without discriminating between phase and earth fault elements of the relay  $R_{jk}$ . Fig. 4 depicts the overall protection and communication logic of the relays.

It is evident that the described fault analysis is an off-line procedure, since one should beforehand know the rated capacity of the DG units and their location, the generator step-up transformer characteristics, and the minimum and maximum penetration level. However, once these data are known there is no need to collect online information about the status of the DG units (connected/disconnected, connection points, etc.).

If there appears a large difference in the short-circuit currents between the grid-connected and the islanded network

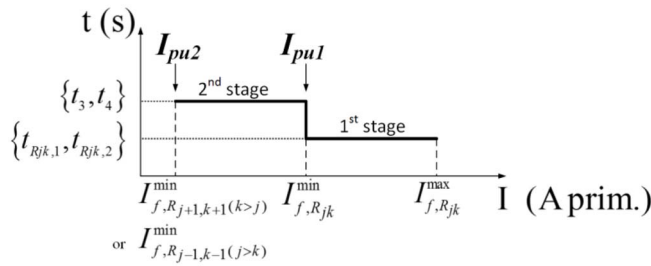

Fig. 3. Overcurrent phase/earth elements setting.

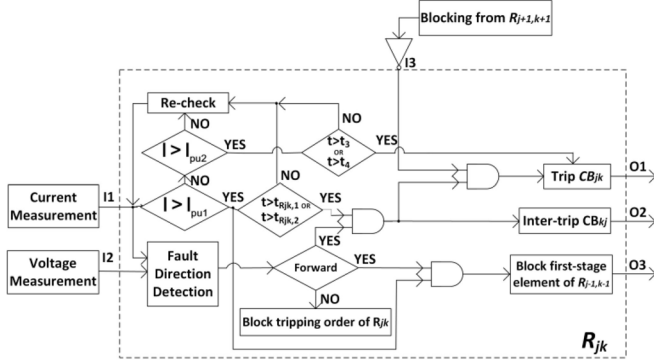

Fig. 4. Internal relay protection and communication logic.

operation, two different setting groups should be available to the relays. The relay will switch to the appropriate setting group based on a signal received from an islanding detection relay or on a substation breaker status signal [23]. Note, that in this case, two different time-overcurrent settings should be defined for each phase/earth element: 1) for the grid-connected; and 2) for the islanded network operation.

### C. Coordination Issues

The time settings of the phase and earth overcurrent elements must be selected in such a way that coordination between the relays and between the relays and the fuses on the laterals is ensured. For example, in a FB scheme, a sufficient first-stage phase/earth DT delay  $t_{Rjk,1}$  and  $t_{Rjk,2}$  is needed in order to provide the fuses enough time to blow first. Thus, if any fault occurs on a lateral, the fuse will blow prior to any relay operation on the main trunk. On the other hand, in an FS scheme, the relays are supposed to operate faster than the fuses. In this case, a faster DT delay or an instantaneous setting must be used for the first-stage phase/earth overcurrent element. Accordingly, the time delay of the relays in the high-voltage to medium-voltage substation should be modified for coordination, if needed.

Usually, every DG unit connected to a distribution network is protected by a great variety of protective relays [24]. Among them, the voltage/frequency, the overcurrent, and the interconnection relay seem to play the most important role regarding coordination issues with the line protection. Based on international standards [25] and the present practice, these devices are intended to immediately disconnect the DG units when a fault appears. In the island-mode, the network is not operable without DG units, while in the grid-mode the scenarios with different penetration levels have been investigated.

### D. Economic Evaluation

The protection equipment requires a considerable investment which depends on the desired reliability level of the protection system. Even if the simplest level of reliability is assumed (i.e., without any redundancy in the protection devices), installing relays and CTs/VTs on every line section definitely increases the implementation cost of the protection system. If this cost is treated as a network reinforcement expense charged only to the distribution system operator (DSO), then this investment will certainly prove economically infeasible.

However, the required investment should be evaluated by also taking into account the operational and maintenance benefits expected to be gained from the DSO and the DG producers due to the protection scheme operation [26]. For example, the cost of electricity supply interruptions, the cost of increased network losses, the outage cost of DG units, as well as power quality or contract/regulatory penalties are critical measures for the DSO and the DG producers and should be included in the economical evaluation of the protection scheme. Note that all those costs are closely related with the operation of the protection system [27], [28].

On the other hand, policy makers continue to motivate the stakeholders for DG investments in distribution systems. Nowadays, the common practice for many DSOs is to demand the immediate disconnection of the DG units in case of a fault. As long as the number of the producers continues to increase, this will not be acceptable so easily, because the producers will not agree to invest if they are forced to lose their production due to any single fault on the line.

The communications infrastructure requires a relatively high investment as well, which is determined from the desired level of speed and redundancy. Note, however, that a communication network is crucial in distribution networks not only for protection reasons but also for implementing various automation operations. Distribution automation may significantly reduce the operating costs in a distribution system [29].

It is evident that, for all the above mentioned reasons, a cost-benefit study [30] must be conducted prior to the final decision concerning the investment. A compromise between the desired cost and reliability of the overall protection scheme is necessary in that case. Within this context, we conceptualize that the required investment could be shared to both beneficial parties (DSO and DG producers) in order to compensate for the obtained benefits: 1) the increased reliability of the distribution system and 2) the increased energy production for the producers by minimizing the possibility of unwanted tripping of the generating units. This could be legislated as an ancillary service, imposed proportionally to both parties.

### E. Limitations of the Method—Advantages and Disadvantages

In this paper, we considered the radial line configuration because this is the most commonly encountered distribution network configuration and because it is simple enough for illustrating the proposed method. In a ring-type network, as that shown in Fig. 5, the same protection scheme can be

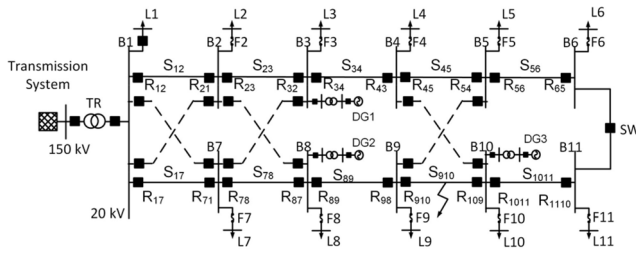

Fig. 5. Meshed distribution network configuration.

applied without any modification, except that the computational effort for the off-line studies increases. However, in a meshed network (shown in Fig. 5 if the dashed lines are connected), the coordination of the relays becomes a very complicated task since a large combination of off-line studies is needed. In some cases it may be hard to find unique relay settings, appropriate for all possible network topologies formed by the different circuit loops and DG connection points. For those cases, it may be considered impractical to apply the proposed protection scheme. It is evident that, if permitted from the operational planning point of view, a radial network reconfiguration would certainly simplify the operation practices and would improve the performance of the protection scheme.

Obviously, the size and complexity of the distribution network affects the computational effort required for the off-line computations. However, this is a task that must be performed only once, that is after a DG unit is going to be connected to or disconnected from the network, which does not happen very often. On the other hand, planning studies restrict the DG penetration to a certain level and the same is true for the number of the possible connection points. Thus, even in the most complex distribution networks, the number of DG units that can be connected to the line is actually limited and not all buses can potentially facilitate a DG unit. Other restraints imposed due to financial and environmental reasons (including the energy resources location if RES are considered instead of conventional DG generators) minimize further the possible locations for DG connection.

One could think to apply differential relays instead of overcurrent ones to implement the protection scheme. Although a differential protection scheme is possible and reliable in general, it does not simplify the implementation and maintenance of the protection system in distribution systems because the differential function must be properly set in too many line sections. On the other hand, overcurrent protection is always required as a backup scheme. Hence, the overcurrent elements of the differential relays should additionally be set for the distribution system to be protected effectively. Moreover, some well-known problems related with the differential protection principle (CTs saturation, line charging currents, unequal burden, inrush currents, harmonic content, etc.) are not so pronounced with overcurrent relays.

Regarding the implementation costs, if long lines are considered, applying differential protection to every line section means that two differential relays are needed, one in every line section terminal. Then, a dedicated and fast communication link is required for allowing the differential relays to

TABLE I  
RECLOSER TIME-OVERCURRENT SETTINGS

Phase Element		Earth Element	
Fast Curve	105 (A)	Fast Curve	105 (A)
Time Dial	0.10	Time Dial	0.13
Slow Curve	IEC-SI (C1)	Slow Curve	IEC-SI (C1)
Time Dial	0.13	Time Dial	0.21
Pickup Current	150 A prim.	Pickup Current	50 A prim.
DT pickup	6200 A prim.	DT pickup	5250 A prim.
DT delay	0.10 s	DT delay	0.15 s

exchange signals, which is a requirement similar to that of the protection scheme proposed in this paper. Thus, the cost of a differential protection scheme is comparable to that of the directional overcurrent scheme since the additional cost of installing the VTs should be compared with the cost of adding one more differential relay in each section.

### III. CASE STUDY

#### A. Test System Description

The proposed overcurrent protection method has been tested on the distribution system of Fig. 1, which consists of one radial 20 kV, 50 Hz, and 50 km long overhead line, equally divided in five segments; a 95 mm<sup>2</sup> aluminium conductor steel reinforced (ACSR) conductor is used on segments  $S_{12}$ ,  $S_{23}$ , and  $S_{34}$ , while a 50 and 35 mm<sup>2</sup> ACSR conductor is used on segments  $S_{45}$  and  $S_{56}$  respectively. The total line load is 7.5 MW and 1.48 MVAR. The load L1, added to the bus B1, represents the total power consumed on an identical feeder supplied from the same substation. The transmission grid is represented by an equivalent source, having a maximum and minimum short-circuit power of 435 and 250 MVA, respectively. A conventional round-rotor synchronous machine with the nominal data 4.08 MW, 10.5 kV, and 50 Hz,  $\cos \varphi_n = 0.85$  has been assumed as a DG unit. Note, however, that the DG units operate with a unity power factor in the grid-connected network operation, while in the islanded network one of the DG units controls the voltage. A 25 MVA, 20 kV (YN)/10.5 kV (D), and 50 Hz step-up transformer has been used in all the DG units. Standard models available in Digsilent Power Factory 15 have been used for representing the described system.

#### B. Recloser-Fuse Coordination

The main feeder is originally protected by a reclosing relay SEL-351R, located at the beginning of the line. This recloser performs one fast and two delayed operations with a reclosing cycle (open intervals) of 0.5–5–10 s. The settings of the phase and earth overcurrent elements of the recloser are shown in Table I. There is no need to supervise the fault direction because originally no DG unit is connected to the line. Hence, only the fault contribution from the external grid is expected. The line laterals are protected by expulsion fuses having a nominal rating of 25 A.

Fig. 6 shows the coordination between the recloser SEL-351R and one of that fuses with the help of a time-overcurrent plot. The green and blue curves correspond

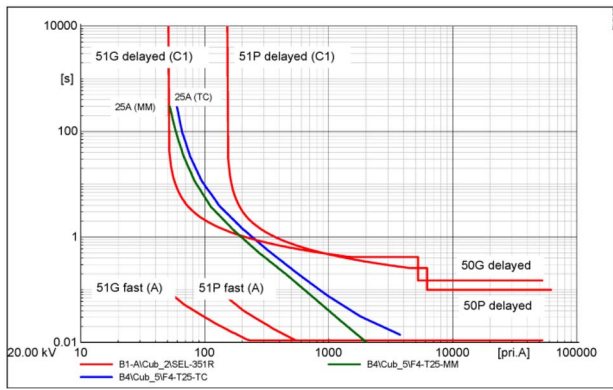

Fig. 6. Coordination graphs for the recloser-fuse scheme (without DG).

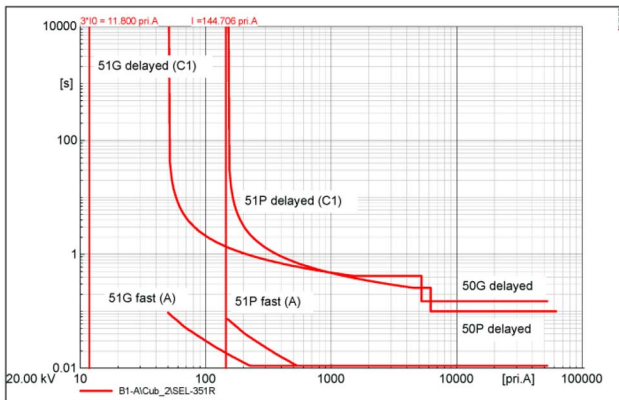

Fig. 7. Overcurrent protection blinding when DG is present.

to the minimum melting (MM) and total clearing (TC) characteristics of the fuse, respectively. An FS logic is followed.

Without DG on the line, the coordination between the recloser and the fuses is guaranteed for any fault occurring everywhere on the line. However, coordination is lost when DG is present. For example, suppose that one DG unit is connected to the bus B4, as shown in Fig. 2. Fig. 7 depicts that under minimum short-circuit conditions in the transmission grid, the recloser (both its phase and earth overcurrent element) cannot even sense a single-phase-ground fault occurring on bus B6. Indeed, on a time-overcurrent plot there is no intersection of the vertical fault current lines with any of the recloser curves. On the other hand, the recloser trips undesirably for a three-phase fault at the beginning of the neighboring feeder (Fig. 8) if maximum fault conditions exist in the transmission system.

### C. Application of the Proposed Protection Scheme

As described in the previous sections, the proposed protection scheme suggests applying directional overcurrent relays at both ends of every line section instead of using the recloser at the beginning of the line. The total active load is 7.5 MW, so a maximum of two DG units can simultaneously be connected to the line if a penetration level close to 100% is desired. Taking this constraint into account, the short-circuit analysis described in Section II-B has been conducted.

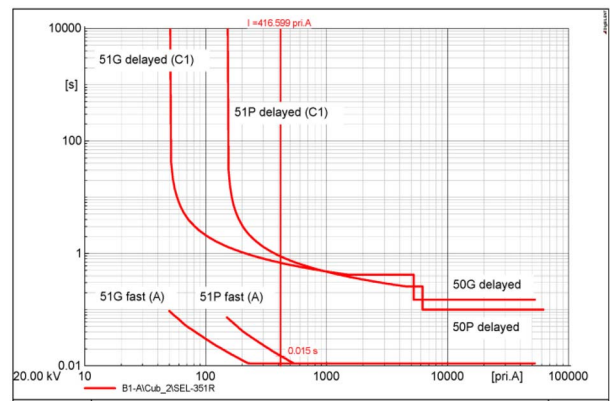

Fig. 8. Nuisance feeder tripping when DG is present.

Table II summarizes the minimum calculated phase ( $I_\varphi$ ) and residual earth ( $3I_o$ ) currents sensed from the relays for faults at the remotest end of their primary protection zone in the grid-connected and in the islanded network. All possible DG connection points have been considered. Due to space limitations the results for the relays looking to the opposite direction (from the line to the external grid) are not included here.

The minimum of all the remotest phase (respectively, residual earth) fault currents seen by the relay  $R_{jk}$  determines the overcurrent setting  $I_{pu1}$  of its first-stage (fastest) DT element, while the minimum of all the remotest phase (respectively, residual earth) fault currents seen by the downstream relay  $R_{j+1,k+1}$  determines the pickup current setting  $I_{pu2}$  of the second-stage (slowest) DT element of the relay  $R_{jk}$ . Those values have been highlighted in Table II for every relay of interest.

Table III concentrates the two-step overcurrent settings determined for every relay following the above mentioned procedure. Due to inaccuracies expected from the current transformers, these settings have been derived by reducing the highlighted values of Table II by 10%. Depending on the relay specifications, the closest available settings to that of Table II should actually be selected.

Note that, since intertripping is applied between the overcurrent relays installed at the opposite ends of the same line section, the relays looking to the grid ( $R_{jk}, j > k$ ) actually have not to be set in the grid-connected mode. Those relays will be intertripped from the forward relays ( $R_{jk}, k > j$ ). Hence, the settings shown with parentheses in Table III can be considered as redundant in case the intertripping fails.

Next, the appropriate time delays  $t_{Rjk,1}, t_{Rjk,2}, t_2$ , and  $t_4$  should be determined to ensure coordination between the relays and the fuses. For a FB scheme, the maximum TC time  $t_{TCFi}^{\max}$  of every fuse  $F_i (i = 2, \dots, 6)$  must be calculated initially. Then, in every related relay-fuse pair, the first-stage tripping time of the relay must be set higher than the sum of the maximum TC time of that fuse and the minimum required CTI ( $CTI_{\min}$ ). The latter is taken 0.3 s. The constant DT delays  $t_2$  and  $t_4$  are determined by adding the  $CTI_{\min}$  to the maximum of all the first-stage time delays ( $t_{Rjk,1}^{\max}$  and  $t_{Rjk,2}^{\max}$ , respectively). In other words, (1) must be satisfied. Of course, coordination

TABLE II  
 REMOTEST PHASE ( $I_\phi$ ) AND RESIDUAL EARTH ( $3I_o$ ) SHORT-CIRCUIT CURRENTS SENSED FROM THE RELAYS IN THEIR PRIMARY ZONE

DG at	$I_\phi / 3I_o$ in Primary kA									
	Islanded Network Operation ( $I_\phi/3I_o$ )					Grid-Connected Network Operation				
	R12	R23	R34	R45	R56	R12	R23	R34	R45	R56
None	No LF <sup>1</sup>	No LF	No LF	No LF	No LF	<b>1.12/0.74</b>	<b>0.63/0.40</b>	<b>0.43/0.27</b>	0.31/0.19	0.23/0.15
B1	No LF	No LF	No LF	No LF	No LF	1.16/0.78	0.64/0.41	0.44/0.27	0.31/0.19	0.23/0.15
B2	No LF	No LF	No LF	No LF	No LF	1.44/ <b>0.20</b>	0.94/0.72	0.56/0.39	0.37/0.26	0.27/0.19
B3	No LF	No LF	No LF	No LF	No LF	1.26/0.71	0.85/ <b>0.08</b>	0.82/0.69	0.48/0.37	0.32/0.25
B4	No LF	No LF	No LF	No LF	No LF	1.18/0.75	0.75/0.38	0.54/ <b>0.04</b>	0.61/0.62	0.38/0.35
B5	No LF	No LF	No LF	No LF	No LF	1.15/0.76	0.69/0.40	0.52/0.25	0.35/ <b>0.03</b>	0.52/0.61
B6	No LF	No LF	No LF	No LF	No LF	1.15/0.76	0.67/0.41	0.48/0.27	0.36/0.18	0.24/ <b>0.02</b>
B1 (2 units)	0.67/0.65	0.50/0.37	0.37/0.25	0.27/0.18	0.21/0.15	1.16/0.78	0.64/0.41	0.44/0.27	0.31/0.19	0.23/0.15
B2 (2 units)	-	0.69/0.67	0.50/0.38	0.35/0.26	0.26/0.19	1.37/0.23	1.00/0.75	0.59/0.41	0.39/0.27	0.28/0.20
B3 (2 units)	-	-	0.71/0.70	0.48/0.38	0.34/0.26	1.23/0.75	0.75/0.10	0.93/0.75	0.53/0.39	0.35/0.27
B4 (2 units)	-	-	-	0.73/0.67	0.44/0.39	1.17/0.77	0.73/0.41	0.47/0.06	0.76/0.69	0.44/0.37
B5 (2 units)	-	-	-	No LF	No LF	1.16/0.77	0.69/0.42	0.51/0.27	<b>0.28/0.04</b>	0.69/0.71
B6 ( 2units)	-	-	-	-	No LF	1.16/0.76	0.68/0.42	0.49/0.28	0.33/0.21	0.19/0.04
B1 & B2	<b>0.44/0.11</b>	0.67/0.65	0.49/0.37	0.34/0.25	0.25/0.19	1.47/0.21	0.95/0.72	0.56/0.39	0.37/0.26	0.27/0.19
B1 & B3	0.45/0.51	<b>0.35/0.06</b>	0.63/0.64	0.44/0.35	0.31/0.24	1.30/0.74	0.84/0.08	0.81/0.69	0.48/0.45	0.32/0.25
B1 & B4	0.45/0.60	0.36/0.31	<b>0.28/0.04</b>	0.54/0.59	0.37/0.34	1.22/0.78	0.76/0.42	0.55/0.05	0.61/0.62	0.38/0.35
B1 & B5	0.45/0.61	0.36/0.36	0.29/0.22	<b>0.21/0.03</b>	0.50/0.59	1.19/0.79	0.70/0.41	0.56/0.25	0.35/0.03	0.52/0.61
B1 & B6	0.45/0.60	0.37/0.36	0.30/0.25	0.22/0.16	<b>0.16/0.02</b>	1.18/0.79	0.68/0.42	0.49/0.27	0.37/0.19	0.24/0.02
B2 & B3	-	0.43/0.11	0.68/0.67	0.46/0.37	0.32/0.25	1.41/0.21	0.99/0.16	0.87/0.72	0.50/0.38	0.33/0.26
B2 & B4	-	0.44/0.52	0.34/0.06	0.58/0.61	0.39/0.36	1.41/0.22	1.00/0.69	0.63/0.07	0.64/0.64	0.41/0.37
B2 & B5	-	0.45/0.60	0.36/0.31	0.25/0.04	0.53/0.62	1.41/0.22	0.97/0.73	0.63/0.37	0.39/0.04	<b>0.18/0.02</b>
B2 & B6	-	0.45/0.60	0.36/0.36	0.27/0.22	0.19/0.03	1.42/0.22	0.96/0.74	0.60/0.40	0.41/0.25	0.26/0.03
B3 & B4	-	-	0.43/0.12	0.63/0.65	0.42/0.37	1.23/0.75	0.77/0.09	0.85/0.15	0.70/0.67	0.42/0.38
B3 & B5	-	-	0.45/0.54	0.32/0.06	0.57/0.66	1.24/0.74	0.77/0.09	0.80/0.67	0.46/0.06	0.57/0.66
B3 & B6	-	-	0.45/0.61	0.34/0.32	0.24/0.04	1.25/0.74	0.78/0.09	0.81/0.71	0.48/0.36	0.30/0.04
B4 & B5	-	-	-	No LF	No LF	1.17/0.77	0.73/0.40	0.49/0.05	0.57/0.12	0.61/0.69
B4 & B6	-	-	-	No LF	No LF	1.18/0.77	0.74/0.40	0.50/0.06	0.65/0.60	0.36/0.06
B5 & B6	-	-	-	-	No LF	1.16/0.77	0.69/0.42	0.52/0.27	0.30/0.04	0.51/0.13

<sup>1</sup> "No LF" means that the load flow is unsolvable or the network operating constraints are violated

TABLE III  
 TIME-OVERCURRENT SETTINGS

Relay	Islanded Operation				Grid-Connected Operation			
	Overcurrent settings (A)		Time settings (s)		Overcurrent settings (A)		Time settings (s)	
	$I_{\phi,pu1}/3I_{o,pu1}$	$I_{\phi,pu2}/3I_{o,pu2}$	$t_{Rjk1}$ (s)	$t_2$ (s)	$I_{\phi,pu1}/3I_{o,pu1}$	$I_{\phi,pu2}/3I_{o,pu2}$	$t_{Rjk1}$ (s)	$t_2$ (s)
R <sub>12</sub>	396/99	315/54	0.45	2.10	1008/180	567/72	0.37	1.75
R <sub>23</sub>	315/54	252/36	0.62	2.10	567/72	387/36	0.48	1.75
R <sub>34</sub>	252/36	189/27	0.85	2.10	387/36	252/27	0.67	1.75
R <sub>45</sub>	189/27	144/18	1.25	2.10	252/27	162/18	0.98	1.75
R <sub>56</sub>	144/18	-	1.77	-	162/18	-	1.45	-
	$I_{\phi,pu1}/3I_{o,pu1}$	$I_{\phi,pu2}/3I_{o,pu2}$	$t_{Rjk2}$ (s)	$t_4$ (s)	$I_{\phi,pu1}/3I_{o,pu1}$	$I_{\phi,pu2}/3I_{o,pu2}$	$t_{Rjk2}$ (s)	$t_4$ (s)
R <sub>21</sub>	171/18	-	0.45	0.80	(153/81)	-	(0.35)	(0.75)
R <sub>32</sub>	198/18	171/18	0.45	0.80	(180/54)	(153/81)	(0.35)	(0.75)
R <sub>43</sub>	225/27	198/18	0.48	0.80	(216/54)	(180/54)	(0.39)	(0.75)
R <sub>54</sub>	270/261	225/27	0.48	0.80	(252/72)	(216/54)	(0.41)	(0.75)
R <sub>65</sub>	342/522	270/261	0.50	0.80	(324/126)	(252/72)	(0.41)	(0.75)

between the relays on the main line must also be ensured

$$\begin{aligned}
 t_{Rjk,1} &= t_{TCFi}^{\max} + CTI_{\min} \\
 t_{Rjk,2} &= t_{TCFi}^{\max} + CTI_{\min} \\
 t_2 &= t_{Rjk,1}^{\max} + CTI_{\min} \\
 t_4 &= t_{Rjk,2}^{\max} + CTI_{\min}.
 \end{aligned} \tag{1}$$

The maximum TC time of a fuse is determined by simulating a number of possible short-circuits at the remotest end of the fuse laterals under different network conditions. It has been

derived from the simulations that, in the grid-connected network, the maximum blowing time of the fuses is experienced when minimum short-circuit conditions hold on the transmission system and none DG unit is in operation. In the islanded network, the maximum TC time is obtained for one DG unit connected to the line.

Table III includes the time delay settings obtained from (1). The time-overcurrent plots for the grid-connected and the islanded mode are shown in Figs. 9 and 10, respectively. These figures refer to the forward relays, while only the TC characteristic of the T25 A fuse is shown. Coordination



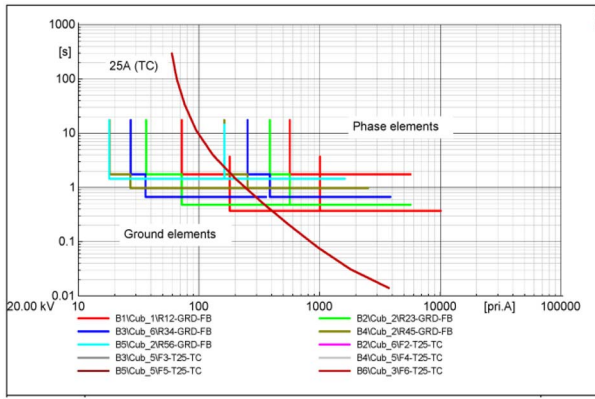

Fig. 9. Relays-fuse coordination for grid-mode operation (FB scheme).

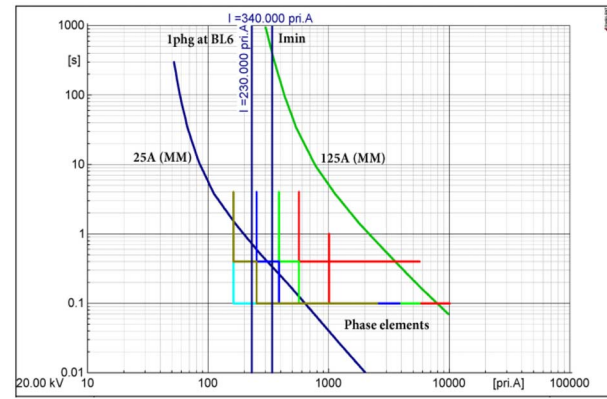

Fig. 11. Relays-fuse coordination for grid-mode operation (FS scheme).

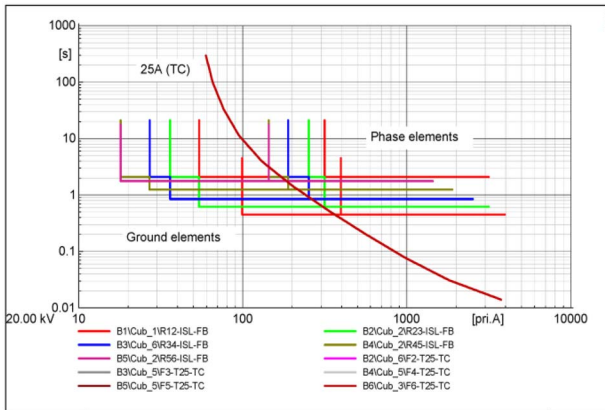

Fig. 10. Relays-fuse coordination for islanded operation (FB scheme).

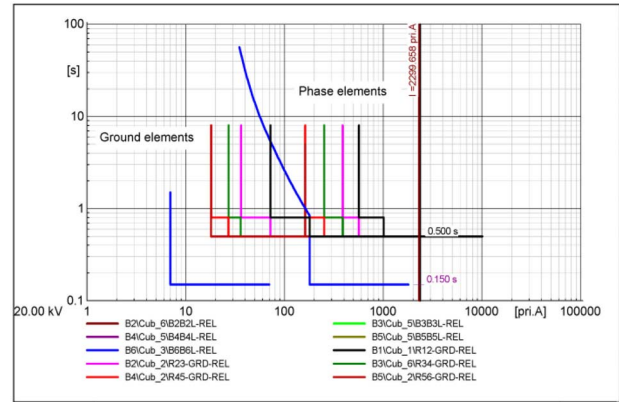

Fig. 12. Relays-relays coordination for grid-connected operation.

between the relays and between the relays and the fuses is guaranteed for any fault.

A similar procedure can be followed if an FS scheme is desired, but now the minimum  $t_{MMFi}^{\min}$  of all the MM times must be calculated for every fuse  $F_i$ . Then, in every related relay-fuse pair, the tripping time of the relay must be set lower than the  $t_{MMFi}^{\min}$  to that of fuse by at least the  $CTI_{\min} = 0.3$  s.

We choose a first-stage DT delay for the relays equal to 0.1 s. With this choice a very fast communication means is needed so as the 15 ms transfer time between the relays is guaranteed. It has been observed that for various lateral faults, coordination between the relays and the 25 A fuses cannot be obtained due to the low MM times. Hence, in order to apply the FS design, the replacement of the existing fuses with ones having a larger rating has been examined. This introduced one additional constraint: the new fuse should melt for the global minimum fault current  $I_{\min}$  at the laterals.

The investigation showed that coordination is achieved when a 125 A rated fuse is selected (Fig. 11), except for the single-phase fault at BL6 which under minimum short-circuit conditions produces a current flow equal to 230 A. The global minimum of all other lateral fault currents is  $I_{\min} = 340$  A.

#### D. Protection Scheme Improvement

Adding relays and CBs to every line section definitely increases the cost of the protection scheme. However, with

DG present in the distribution line this can be considered to some extent inevitable. There is one more option available to improve further the performance of the protection scheme; replacing the fuses on the laterals with overcurrent relays. Such a revamping adds an extra cost to the DSO, but the overall improvement can compensate this cost.

Based on the above, we decided to replace every fuse on the laterals with an overcurrent relay having: 1) an extremely inverse phase element which picks-up for currents larger than 125% of the lateral line load; 2) a DT phase element which trips for currents larger than 180 A that is 20% less than the minimum calculated fault current at the remotest lateral end; and 3) a DT earth element which picks-up for currents larger than 30% of the lateral line load.

A fast response of 0.15 s is decided for the phase and earth DT elements of the lateral relays, which subsequently leads to a first-stage DT setting of the relays in the main line equal to 0.5 s if assuming a  $CTI_{\min}$  of at least 0.3 s. The second-stage is set with a time delay equal to 0.8 s. Note that the overcurrent settings of the main line relays remain unchanged.

The time-overcurrent plot for the forward looking relays in the grid-connected network is shown in Fig. 12. The close-in three-phase fault at fuse F2 is depicted in the same figure, as a simple example of protection coordination.

## IV. CONCLUSION

This paper proposes a communication-based protection scheme for radial distribution lines with DG. The scheme implements common directional overcurrent relays, assisted by intertripping and blocking transfer functions, and guarantees selectivity between the relays in the main trunk and the fuses at the laterals under all possible operating conditions. If relays are installed at the laterals instead of fuses, protection reliability can further increase.

## REFERENCES

- [1] P. M. Anderson, *Power System Protection*. Piscataway, NJ, USA: IEEE Press, 1998, p. 1330.
- [2] S. M. Brahma and A. A. Girgis, "Microprocessor-based reclosing to coordinate fuse and recloser in a system with high penetration of distributed generation," in *Proc. 2002 IEEE Power Energy Soc. Winter Meeting Conf.*, vol. 1. New York, NY, USA, pp. 453–458.
- [3] A. Zamani, T. Sidhu, and A. Yazdani, "A strategy for protection coordination in radial distribution networks with distributed generators," in *Proc. 2010 IEEE Power Energy Soc. Gen. Meeting Conf.*, Minneapolis, MN, USA, pp. 1–8.
- [4] S. M. Brahma and A. A. Girgis, "Development of adaptive protection scheme for distribution systems with high penetration of distributed generation," *IEEE Trans. Power Del.*, vol. 19, no. 1, pp. 56–63, Jan. 2004.
- [5] H. B. Funmilayo and K. L. Butler-Purry, "An approach to mitigate the impact of distributed generation on the overcurrent protection scheme for radial feeders," in *Proc. 2009 IEEE/PES Power Syst. Conf. Expo.*, Seattle, WA, USA, pp. 1–11.
- [6] I. Xyngi and M. Popov, "An intelligent algorithm for the protection of smart power systems," *IEEE Trans. Smart Grid*, vol. 4, no. 3, pp. 1541–1548, Sep. 2013.
- [7] P. Mahat, Z. Chen, B. Bak-Jensen, and C. L. Bak, "A simple adaptive overcurrent protection of distribution systems with distributed generation," *IEEE Trans. Smart Grid*, vol. 2, no. 3, pp. 428–437, Sep. 2011.
- [8] M. Dewadasa, A. Ghosh, and G. Ledwich, "Protection of distributed generation connected networks with coordination of overcurrent relays," in *Proc. 37th Annu. Conf. IEEE Ind. Elect. Soc. (IECON)*, Melbourne, VIC, Australia, 2011, pp. 924–929.
- [9] A. Sinclair, D. Finney, D. Martin, and P. Sharma, "Distance protection in distribution systems: How it assists with integrating distributed resources," *IEEE Trans. Ind. Appl.*, vol. 50, no. 3, pp. 2186–2196, May/June 2014.
- [10] C. Jecu *et al.*, "Protection scheme based on non communicating relays deployed on MV distribution grid," in *Proc. 2013 PowerTech*, Grenoble, France, pp. 1–6.
- [11] S. Javadian, M. R. Haghifam, and N. Rezaei, "A fault location and protection scheme for distribution systems in presence of dg using MLP neural networks," in *Proc. 2009 IEEE Power Energy Soc. Gen. Meeting Conf.*, Calgary, AB, Canada, pp. 1–8.
- [12] H. Zayandehroodi, A. Mohamed, H. Shareef, and M. Farhoodnea, "A novel neural network and backtracking based protection coordination scheme for distribution system with distributed generation," *Int. J. Elect. Power Energy Syst.*, vol. 43, no. 1, pp. 868–879, 2012.
- [13] J. Ma, X. Wang, Y. Zhang, Q. Yang, and A. G. Phadke, "A novel adaptive current protection scheme for distribution systems with distributed generation," *Int. J. Elect. Power Energy Syst.*, vol. 43, no. 1, pp. 1460–1466, 2012.
- [14] N. El Halabi, M. García-Gracia, J. Borroy, and J. L. Villa, "Current phase comparison pilot scheme for distributed generation networks protection," *Appl. Energy*, vol. 88, no. 12, pp. 4563–4569, 2011.
- [15] E. Sortomme, S. S. Venkata, and J. Mitra, "Microgrid protection using communication-assisted digital relays," *IEEE Trans. Power Del.*, vol. 25, no. 4, pp. 2789–2796, Oct. 2010.
- [16] M. Dewadasa, A. Ghosh, and G. Ledwich, "Protection of microgrids using differential relays," in *Proc. 21st Australas. Univ. Power Eng. Conf. (AUPEC)*, Brisbane, QLD, Australia, 2011, pp. 1–6.
- [17] E. Sortomme, J. Ren, and S. S. Venkata, "A differential zone protection scheme for microgrids," in *Proc. 2013 IEEE Power Energy Soc. Gen. Meeting Conf.*, Vancouver, BC, Canada, pp. 1–5.
- [18] O. Rintamaki and J. Ylinen, "Communicating line differential protection for urban distribution networks," in *Proc. 2008 China Int. Conf. Elect. Distrib. (CICED)*, Guangzhou, China, pp. 1–5.
- [19] G. G. Karady, A. Rogers, and V. Iyengar, "Feasibility of fast pilot protection for multi-load distribution systems," in *Proc. 2013 IEEE Power Energy Soc. Gen. Meeting Conf.*, Vancouver, BC, Canada, pp. 1–5.
- [20] K. Zimmerman and D. Costello, "Fundamentals and improvements for directional relays," in *Proc. 63rd Annu. Conf. Prot. Relay Eng.*, College Station, TX, USA, 2010, pp. 1–12.
- [21] IEEE Power System Relaying Committee, Relaying Communications Subcommittee. (Jan. 14, 2013). *Communications Technology for Protection Systems*. [Online]. Available: [http://www.pes-psrc.org/Reports/APublications\\_new\\_format.htm](http://www.pes-psrc.org/Reports/APublications_new_format.htm)
- [22] *Network Protection and Automation Guide*, AREVA, Paris, France, 2005, p. 500.
- [23] S. P. Chowdhury, S. Chowdhury, and P. A. Crossley, "Islanding protection of active distribution networks with renewable distributed generators: A comprehensive survey," *Elect. Power Syst. Res.*, vol. 79, no. 6, pp. 984–992, Jun. 2009.
- [24] D. Hornak and N. H. Chau, *Distributed Generation Interconnections: Protection, Monitoring and Control Opportunities*. Highland, IL, USA: Basler Elect, 2002.
- [25] *IEEE Standard for Interconnecting Distributed Generation: How Could It Help My Facility?* IEEE Standard 1547-2003, Nov. 2003.
- [26] C. Gellings, "Estimating the costs and benefits of the smart grid. A preliminary estimate of the investment requirements and the resultant benefits of a fully functioning smart grid," *Elect. Power Res. Inst.*, Palo Alto, CA, USA, Tech. Rep. 1022519, Mar. 2011. [Online]. Available: <http://www.epri.com/abstracts/Pages/ProductAbstract.aspx?ProductId=000000000001022519>
- [27] C. A. P. Meneses and J. R. S. Mantovani, "Improving the grid operation and reliability cost of distribution systems with dispersed generation," *IEEE Trans. Power Syst.*, vol. 28, no. 3, pp. 2485–2496, Aug. 2013.
- [28] M. E. Samper and A. Vargas, "Investment decisions in distribution networks under uncertainty with distributed generation—Part I: Model formulation," *IEEE Trans. Power Syst.*, vol. 28, no. 3, pp. 2331–2340, Aug. 2013.
- [29] M. Lehtonen and S. Kupari, "A method for cost benefit analysis of distribution automation," in *Proc. 1995 Int. Conf. Energy Manage. Power Del.*, vol. 1. Singapore, pp. 49–54.
- [30] V. Giordano, I. Onyeji, G. Fulli, M. S. Jimenez, and C. Filliou, "Guidelines for conducting a cost-benefit analysis of smart grid projects," European Commission, Joint Res. Centre, Inst. Energy Transport, Brussels, Belgium, Tech. Rep. EUR 25246 EN, 2012. [Online]. Available: <http://ec.europa.eu/energy/en/content/guidelines-conducting-cost-benefit-analysis-smart-grid-projects>

**Vassilis C. Nikolaidis** (M'11) received the Diploma degree in electrical and computer engineering from the Democritus University of Thrace, Xanthi, Greece, in 2001, and the M.Sc. degree in energy engineering and management and the Ph.D. degree in engineering from the National Technical University of Athens, Athens, Greece, in 2002 and 2007, respectively.

From 2008 to 2012, he was a Power Systems Consulting Engineer with PROTASIS SA, Athens, Greece. He is currently a Lecturer with the Department of Electrical and Computer Engineering, Democritus University of Thrace. His current research interests include power system protection, control, stability, and transients.

**Evangelos Papanikolaou** received the D.Eng. degree in electrical and computer engineering from the Democritus University of Thrace, Xanthi, Greece, in 2013.

His current research interests include power system protection and energy systems.

**Anastasia S. Safigianni** (M'97–SM'11) received the D.Eng. and Ph.D. degrees from the Democritus University of Thrace, Xanthi, Greece, in 1981 and 1988, respectively, both in electrical engineering.

She is currently an Associate Professor with the Department of Electrical and Computer Engineering, Democritus University of Thrace. Her current research interests include power systems and electrical installations, short-circuit losses and forces in metal enclosed arrangements, power systems planning and optimization, lighting systems, influence of extra low frequencies electric and magnetic fields on human beings, and distributed generation.