

# Modeling and Control Design of Continuous Stirred Tank Reactor System

M. SAAD, A. ALBAGUL, D. OBIAD  
 Department of Control Engineering  
 Faculty of Electronic Technology  
 P. O. Box 38645, Baniwalid  
 LIBYA  
 albagoul@yahoo.com

*Abstract:* - Continuous stirred tank reactor system (CSTR) is a typical chemical reactor system with complex nonlinear characteristics where an efficient control of the product concentration in CSTR can be achieved only through accurate model. The mathematical model of the system was derived. Then, the linear model was derived from the nonlinear model. A conventional PI controller and PID controller for continuous stirred tank reactor are proposed to control the concentration of the linear CSTR. The simulation study has been done in MATLAB SIMULINK. The best controller has been chosen by comparing the criteria of the response such as settling time, rise time, percentage of overshoot and steady state error. From the simulation result the PID controller has a better performance than conventional PI controller.

*Key-Words:* - Dynamic modeling, PI and PID controllers, Stirred tank system, Matlab and Simulink

## 1 Introduction

The best way to learn about control systems is to design a controller, apply it to the system and then observe the system in operation. One example of systems that use control theory is Continuous stirred tank reactor system (CSTR). It can usually be found in most university process control labs used to explain and teach control system engineering. It is generally linked to real control problems such as chemical factories, preparing of the antidotes in medicine and food processing too. It is widely used because it is very simple to understand; yet the control techniques that can be studied cover many important classical and modern design methods. Continuous stirred tank reactor system (CSTR) is a typical chemical reactor system with complex nonlinear characteristics. The system consists of two tanks as illustrated in Figure 1. The concentration of the outlet flow of two chemical reactors will be forced to have a specified response. It is assumed that the overflow tanks are well-mixed isothermal reactors, and the density is the same in both tanks. Due to the assumptions for the overflow tanks, the volumes in the two tanks can be taken to be constant, and all flows are constant and equal. It is assumed that the inlet flow is constant. It is desired to control of the second tank concentration based on

the concentration in the first tank. One of the popular controllers both in the realm of the academic and industrial application is the PI and PID controllers. They have been applied in feedback loop mechanism and extensively used in industrial process control. Easy implementation of both controllers, made it in system control applications. It tries to correct the error between the measured outputs and desired outputs of the process in order to improve the transient and steady state responses as much as possible. In one hand, PI controller appear to have an acceptable performance in some systems, but sometimes there are functional changes in system parameters that need an adaptive based method to achieve more accurate response. Several researches are available that combined the adaptive approaches on PI controller to increase its performance with respect to the system variations. Limitations of traditional approaches in dealing with constraints are the main reasons for emerging the powerful and flexible methods. In this paper a PI and PID controllers for unstable continuous stirred tank reactor are proposed to control the concentration of the linear CSTR. The performance of the PID controller will be compared with a conventional PI controller using Matlab Simulink. Finally, the task of this paper is to design and select the best controller for the system that can control the concentration of the CSTR.

## 2 Modeling of the continuous stirred tank reactor system

The concentration of the outlet flow of two chemical reactors will be forced to have a specified response in this section. Figure 1 shows the simple concentration process control. It is assumed that the overflow tanks are well-mixed isothermal reactors, and the density is the same in both tanks. Due to the assumptions for the overflow tanks, the volumes in the two tanks can be taken to be constant, and all flows are constant and equal. It is assumed that the inlet flow is constant. Figure 2 shows the block diagram of two tanks of chemical reactor.

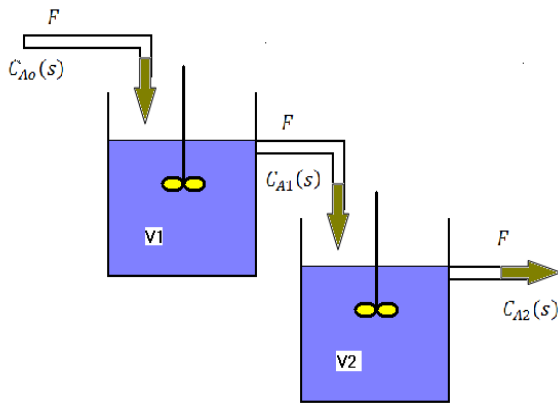

Fig.1 The simple concentration process control

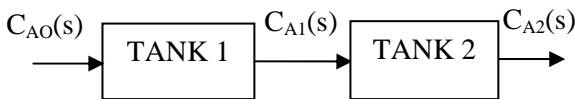

Fig. 2 The block diagram of the two tank system

The value of the concentration in the second tank is desired, but it depends on the concentration in the first tank. Therefore the component balances in both tanks are formulated. The transfer function of the first tank can be obtained as;

$$V_1 \frac{dC_{A1}}{dt} = FC_{A0} - FC_{A1} - V_1 K C_{A1} \quad (1)$$

Where  $V_1$  is the volume of the first tank,  $F$  is the flow,  $C_{A0}$  is the inlet concentration of the first tank,  $C_{A1}$  is the outlet concentration of the first tank and inlet concentration of the second tank and  $K$  is the reaction rate. Equation 1 can be rearranged to be

$$\frac{dC_{A1}}{dt} + \frac{1}{\tau_1} C_{A1} = \frac{F}{V_1} C_{A0} \quad (2)$$

Where  $\tau_1 = \frac{V_1}{F + KV_1}$  is the time constant of the first tank.

By taking Laplace transform and rearranging equation 2, the transfer function of the first tank can be expressed as

$$\frac{C_{A1}(s)}{C_{A0}(s)} = \frac{K_{P1}}{(\tau_1 s + 1)} \quad (3)$$

Where  $K_{P1} = \frac{F}{F + KV_1}$  is the gain of the transfer function of the first tank. The transfer function of the second tank can be derived

$$V_2 \frac{dC_{A2}}{dt} = FC_{A1} - FC_{A2} - V_2 K C_{A2} \quad (4)$$

Where  $V_2$  and  $C_{A2}$  are the volume and the inlet concentration of the second tank respectively. Equation 4 can be rearranged to be

$$\frac{dC_{A2}}{dt} + \frac{1}{\tau_2} C_{A2} = \frac{F}{V_2} C_{A1} \quad (5)$$

Where  $\tau_2 = \frac{V_2}{F + KV_2}$  is the time constant for the second tank. By taking Laplace transform and rearranging equation 5, the transfer function of the second tank can be obtained.

$$\frac{C_{A2}(s)}{C_{A1}(s)} = \frac{K_{P2}}{(\tau_2 s + 1)} \quad (6)$$

Where  $K_{P2} = \frac{F}{F + KV_2}$  is the gain of the transfer function of the second tank. The transfer function of the whole system can be obtained according to the following assumptions of parameters.

- 1- The flow rate is constant for the whole system  $F = 0.085 m^3 / \text{min}$ .
- 2- The volume of the two tanks is the same  $V_1 = V_2 = V = 1.05 m^3$ .
- 3- Reaction rate  $K = 0.04 \text{ min}^{-1}$ .

Since the time constants and the gains are equal for both tanks, they can be computed as follows:

$$\tau = \frac{V}{F + KV} = 8.25 \text{ min}$$

$$K = \frac{F}{F + KV} = 0.669$$

The transfer function of the combined two tanks with the assumed parameters can be obtained

$$G(s) = \frac{C_{A2}(s)}{C_{A0}(s)} = \frac{K_p^2}{(\tau_2 s + 1)^2} \quad (7)$$

$$G(s) = \frac{0.0066}{s^2 + 0.2424s + 0.0147} \quad (8)$$

Figure 3 shows the block diagram of the open loop combined two tank system.

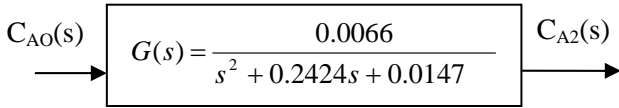

Fig. 3 The block diagram of the open loop system

### 3 Control strategy for the two tank system

In the section a control strategy for the two-tank system will be discussed and presented. The control strategy will be based on the proportional plus integral (PI) and the proportional plus integral plus derivative (PID) techniques. The proportional control mode produces a change in the controller output proportional to the error signal. Meanwhile, the integral control mode changes the output of the controller by an amount proportional to the integral of the error signal. Therefore, the integral mode is frequently combined with the proportional mode to provide an automatic reset action that eliminates the proportional offset. The combination is referred to as the proportional plus integral (PI) control mode. The integral mode provides the reset action by constantly changing the controller output until the error is reduced to zero. The proportional mode provides change in the controller output that is proportional to the error signal. The integral modes provide an additional change in the output that is proportional to the integral of the error signal. The reciprocal of integral action rate is the time required for the integral mode to match the change in output produce by the proportional mode. One problem with the integral mode is that it increases the tendency for oscillation of the controller variable. The gain of the proportional controller must be reduced when it is combined with the integral mode. This reduces the ability of the controller to respond to rapid load changes. If the process has a large dead time lag, the error signal will not immediately reflect the actual error in the process. This delay often results in overcorrecting by the integral mode, that is, the integral mode continues to change the controller output after the error is actually reduced to zero, because it is acting on an "old" signal. The proportional plus integral control mode is used on processes with large load changes when the proportional mode along is not capable of reducing the offset to an acceptable level. The integral mode provides a reset action that eliminates the proportional offset. The primary reason for the derivative action is to improve the closed loop stability. Controllers with proportional and derivative action can be interpreted in a way that the

control is made proportional to the predicted output of the system. The effect of derivative action is to increase the damping in the response and generally improve the stability by reducing the settling time. Therefore, it is useful in reducing the oscillation caused by the integral action in the system response. The time domain equation of the proportional plus integral plus derivative mode is

$$u(t) = K_p e(t) + K_I \int_0^t e(t) dt + K_D \frac{de(t)}{dt} \quad (9)$$

The first step is to test the performance of the system for a step change in the out put without a controller to examine the uncontrolled response. The step response of the closed loop of the linear CSTR system has been taken to see the behavior of this system in closed loop mode, where the response of this system without controller is carried out using SIMULINK. The block diagram in Figure 4 illustrates the construction of closed loop system for CSTR system in SIMULINK. Figure 5 shows the output response of the system for a step change without a controller.

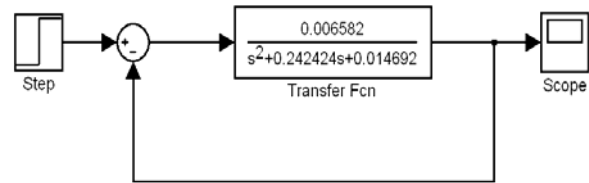

Fig. 4 Simulink block diagram of the system without controller

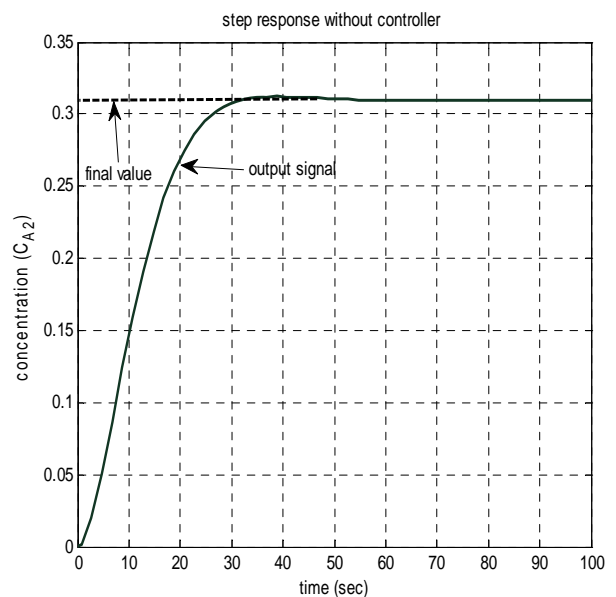

Fig. 5 Step response of system without controller

Table 1 illustrates the Performance specification that defines the system response for the step response input for the system. The final value is 0.30943, but the desired value is 1 in order to make the error steady state zero. From this case, the response has high error compared with the desired value .So the controller is needed to eliminate this error.

Table I Performance specification of step response for the system without controller

S-S Error	Over shoot	Rise time	Settling time
0.691	0%	20 sec	28

### 3.1 Design of the controller using Ziegler-Nichols step response method

The design of a controller for the system will be presented and investigated. There are many techniques to design and tune a PI and PID controllers. Ziegler-Nichols [3] gave two methods to tune the controller parameters. These methods are based on experimental procedure on the system response to the step changes in the input. These methods are still widely used in many applications. This method is based on the step response of the open-loop of the dynamic system. In this method it has been noticed that many dynamic systems exhibit a process reaction curve from which the controller parameters can be estimated. This curve can be obtained from either experimental data or dynamic simulation of the model. This method is firstly used for continuous systems but it can also be used for discrete systems if the sampling rate is very fast. The output response of the open loop of the dynamic model of the mobile robot was obtained, as shown in figure 6, to determine the parameters.

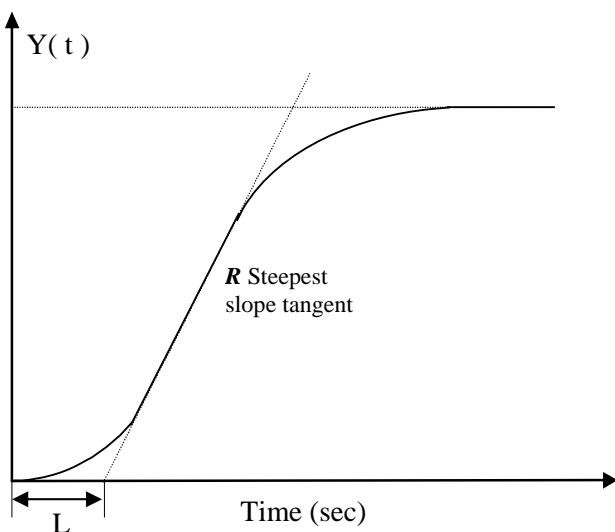

Fig. 6 Process step response

The response will then reduced just to two main parameters, the time delay,  $L$ , and the steepest slope for the response,  $R$ , which defined in figure 5. The final values of the parameters for the PI controller can be calculated according to table II.

Table II Controller parameters tuning using transient response

Type	$K_p$	$T_I$	$T_D$
P	$1/RL$		
PI	$0.9/RL$	$3L$	
PID	$1.2/RL$	$2L$	$L/2$

### 3.2 Simulation and results

The PI controller parameters are first determined using the Ziegler-Nichols transient response method which produced coefficients ( $K_p = 7$  and  $K_I = 0.75$ ). These values were then fined tuned to produce a heuristic optimal response with coefficient values ( $K_p = 5$  and  $K_I = 0.25$ ). Meanwhile, the PID controller parameters are ( $K_p = 6$ ,  $K_I = 1$  and  $K_D = 5$ ). These values were then fined tuned to produce a heuristic optimal response with coefficient values ( $K_p = 4.5$ ,  $K_I = 0.3$  and  $K_D = 10$ ). Figure 7 shows the output responses for the systems under PI controller. Meanwhile the output response for the PID controllers is shown in figure 8. Figure 9 show the output comparison ion between the PI and PID controllers. It can be seen from that the PID controller has improved the performance of the system over the PI controller. The percentage overshoot has improved by approximately 59%. The settling time is also improved by 58%. However the rise time has improved by. The steady-state error is zero in both cares.

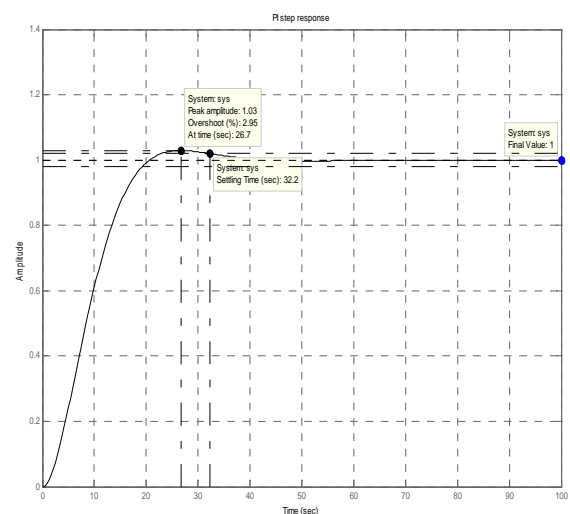

Fig. 7 The output response for PI controller

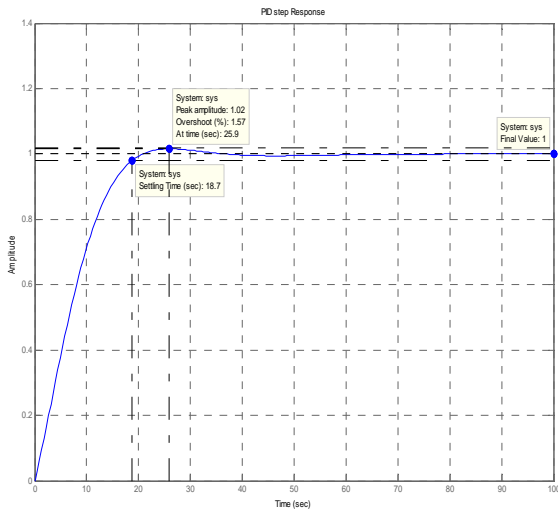

Fig. 8 The output response for PID controller

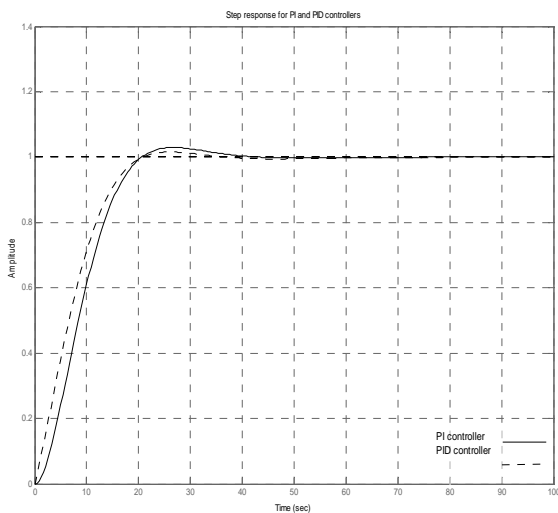

Fig. 9 The comparison between PI and PID controller

## 4 Conclusion

In conclusion, this project was successfully done where two controllers have been designed and the other objectives of this project are achieved. A model for a CSTR system is successfully designed and developed. With these two types of controller the best controller must be determined. It is chosen based on some criterion such as small settling time and rise time, has no steady-state error and has no overshoot. Because these criteria cannot be achieved at one time, it is necessary to decide which criterion we want the most. For CSTR system, the most required criterion is that the system has a no overshoot and zero steady-state error. Between these controllers, a comparison has been done to see

which controller can meet the criterion. From the result and discussion section, the two controllers successfully designed were compared. The response of each controller was plotted in one window as illustrated in Figures 7 and 8. The simulation results show that the PID controller has the best performance because it has zero steady-state error at lowest time. It takes short time to reach the steady state. Furthermore, it has less overshoot. Hence, it can be concluded that between PI controller and PID controller, the best controller for the continuous stirred tank reactor system (CSTR) is the PID controller.

## References:

- [1] J Prakash and K Srinivasan, "Design of nonlinear PID controller and nonlinear model predictive controller for a continuous stirred tank reactor," ISA Transactions, 48, 2009.
- [2] Ahmad Ali and Somanath Majhi, "PI/PID controller design based on IMC and percentage overshoot specification to controller set point change," ISA Transactions, vol. 48, 2009.
- [3] V Rajinikanth and K Latha, "Identification and control of unstable biochemical reactor," International Journal of Chemical Engineering and Applications, vol. 1, no. 1, June 2010.
- [4] Nina F Thornhill, Sachin C Patwardhan, Sirish L Shah, "A continuous stirred tank heater simulation model with applications," Journal of Process Control, 18, 2008.
- [5] B Wayne Bequette, Process Control: Modeling, Design and Simulation, Prentice Hall India, 2008.
- [6] Kiam Heong Ang, Gregory Chong and Yun Li, "PID control system analysis, design and technology," IEEE Transactions on Control System Technology, vol. 13, no. 4, July 2005.
- [7] Yun Li, Kiam Heong Ang and Gregory C Y Chong, "PID control system analysis and design," IEEE Control Systems Magazine, Feb 2006.
- [8] Jose Alvarez-Ramirez, America Morales, "PI control of continuously stirred tank reactors: stability and performance," Chemical Engineering Sciences, 55, 2000.
- [9] Nise, N.S., Control Systems and Engineering. Addison Wesley, 2000.
- [10] Dorf, R. C and Bishop, R. H "Modern control systems" Prentice-Hall, 2009.
- [11] John, V. "Feedback control systems" Prentice-Hall International Inc, USA, 1994. Astrom, K.J. and Wittenmark, B. "Adaptive control" Addison-Wesley, USA, 1989.
- [12] Rahmat, M. F, Yazdani, A. M, Movahed, M. A and Zadeh, S. M "Temperature control of a continuous stirred tank reactor by means of two different intelligent strategies" May 2011.
- [13] Malin, T. E "Process control: Design process and control system for dynamic performance" McGraw Hill, USA, 2000.